

Revision Date: March 5, 2024

Matreneu® Percutaneous Balloon Compression Kit

Instructions for Use



Contents

1. Main Technical Performance Indicators of the Product	3
2. Main Structure and Components of the Product	4
3. Intended Use	6
4. Indications	6
5. Contraindications	7
6. Precautions	7
7. Instructions for Use	8
8. Pressure Gauge Error Prompt	10
9. Maintenance, Storage and Transportation Requirements	11
10. Expected clinical benefit	11
11. Product Service Life and Disposal Requirements	11
12. Packaging & Accessories	11
13. Links to the Summary of Safety and Clinical Performance	11
14. IFU website link	11
15. Electromagnetic Compatibility	11
16. Explanation of Graphics, Symbols, and Abbreviations Used in the Label	14
17. Medical Disclaimer	15

1. Main Technical Performance Indicators of the Product

1.1. Model/specification and dimensions of the balloon catheter (Table 1)

Table 1. Model/specification and dimensions of the balloon catheter

Model/Specification	Maximum Liquid Filling Volume	Diameter of Balloon after Dilation	Length of Balloon after Dilation	Total Length of Catheter	Outer Diameter of Catheter
PBC-0835	0.6 mL	8 mm	10 mm	35 cm	4Fr (1.38 mm)
PBC-0850				50 cm	
PBC-0880				80 cm	
PBC-1035	1.0 mL	10 mm	14 mm	35 cm	
PBC-1050				50 cm	
PBC-1080				80 cm	
PBC-1235	1.4 mL	12 mm	14 mm	35 cm	
PBC-1250				50 cm	
PBC-1280				80 cm	

1.2. Model/specification and dimensions of the puncture needle (Table 2)

Table 2. Model/specification and dimensions of the puncture needle

Model	Diameter of outer sheath	Diameter of inner needle	Effective length
13G	2.30 mm	1.85 mm	110 mm
		1.0 mm	125 mm
		1.55 mm	
14G	2.10 mm	1.65 mm	110 mm
		1.0 mm	125 mm
		1.55 mm	
15G	1.90 mm	1.55 mm	110 mm
		1.0 mm	125 mm
		1.55 mm	

1.3. Model/specification of the syringe (Table 3)

Table 3. Model/specification of the syringe

Model/Specification	Nominal Capacity	Minimum Division Value
SS-01	1 mL	0.02 mL
SS-02	2 mL	0.1 mL

1.4. Model/specification and dimensions of the connector (Table 4)

Table 4. Model/specification and dimensions of the connector

Model/Specification	Outer Diameter of Connecting Tube	Total Length
CT-02	2 mm	310 mm

1.5. Model/specification of the pressure gauge (Table 5)

Table 5. Model/specification of the pressure gauge

Model/Specification	Pressure Range	Display Resolution	Intrinsic Error	
BPI	-10~600 kPa	1 kPa	-10~540 kPa	540~600 kPa
			±3%	±4%

1.6. Model/specification of the Matreneu® Percutaneous Balloon Compression Kit (Table 6)

Table 6. Model/specification of the Matreneu® Percutaneous Balloon Compression Kit

Component Model Kit	Balloon Catheter	Puncture Needle	Syringe	Connector	Pressure Gauge
PBCS-083513	PBC-0835	13G	SS-01 SS-02	CT-02	BPI
PBCS-083514		14G			
PBCS-083515		15G			
PBCS-085013	PBC-0850	13G			
PBCS-085014		14G			
PBCS-085015		15G			
PBCS-088013	PBC-0880	13G			
PBCS-088014		14G			
PBCS-088015		15G			
PBCS-103513	PBC-1035	13G			
PBCS-103514		14G			
PBCS-103515		15G			
PBCS-105013	PBC-1050	13G			
PBCS-105014		14G			
PBCS-105015		15G			
PBCS-108013	PBC-1080	13G			
PBCS-108014		14G			
PBCS-108015		15G			
PBCS-123513	PBC-1235	13G			
PBCS-123514		14G			
PBCS-123515		15G			
PBCS-125013	PBC-1250	13G			
PBCS-125014		14G			
PBCS-125015		15G			
PBCS-128013	PBC-1280	13G			
PBCS-128014		14G			
PBCS-128015		15G			

2. Main Structure and Components of the Product

This product primarily consists of five parts, i.e. the balloon catheter, puncture needle, syringe, connector, and pressure gauge.

2.1. Structure of the balloon catheter (Fig. 1)

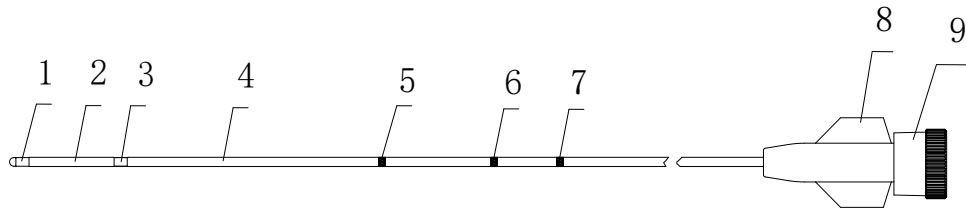

1. Visualization marker ring I 2. Balloon 3. Visualization marker ring II 4. Catheter 5. Scale mark I 6. Scale mark II 7. Scale mark III 8. Luer lock 9. Cap

Fig. 1 Structure of the balloon catheter

2.2. Structure of the puncture needle (Fig. 2)



1. 50 mm scale mark 2. 100 mm scale mark 3. Outer sheath hub 4. Inner needle hub

Fig. 2 Structure of the puncture needle

2.3. Structure of the syringe (without needle) (Fig. 3)

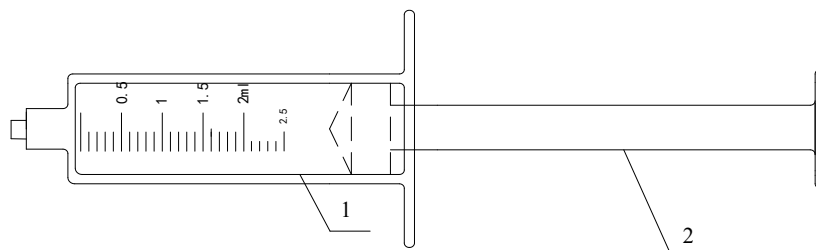

1. Outer barrel 2. Plunger

Fig. 3 Structure of the syringe (without needle)

2.4. Structure of the connector (Fig. 4)

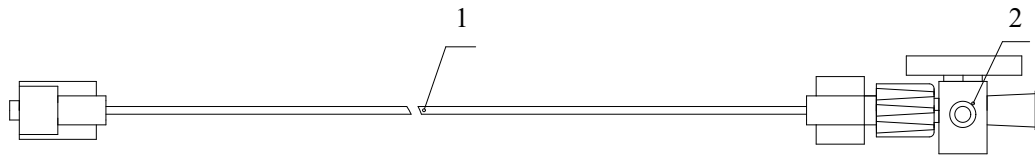

1. Connecting tube 2. Three-way valve

Fig. 4 Structure of the connector

2.5. Structure of the pressure gauge (Fig. 5)

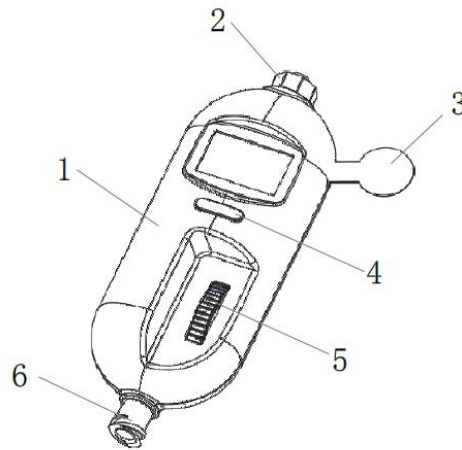

1. Pressure gauge 2. Connector 1 3. Battery insulation strip 4. Button 5. Knob
6. Connector 2

Fig. 5 Structure of the pressure gauge

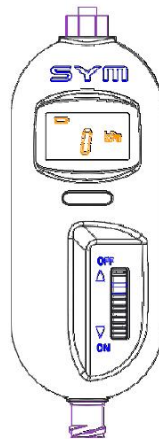

Fig. 6 Pressure gauge display after start up

3. Intended Use

This product is applicable to the Percutaneous Balloon Compression (PBC) procedure for trigeminal neuralgia.

4. Indications

Primary trigeminal neuralgia.

5. Contraindications

Patients with severe visceral lesions, coagulation disorders, aneurysms, vascular malformations and other vascular lesions affecting the ipsilateral middle cranial base, CPA or puncture paths or trigeminal neurinomas or meningiomas affecting the ipsilateral Meckel's cave, and bony spurs in the Meckel's cavity.

6. Precautions

- 6.1. This product should be used by trained doctors who are capable of strictly identifying the indications. Surgeons must undergo specialized training to master this technique and should carefully read the instructions before the use of this product. Paper IFU were attached to the device.
- 6.2. This product has been sterilized with Ethylene Oxide. Please check the product packaging for damages before use, and replace the product at once if damages are identified.
- 6.3. This product is a disposable product, repeated use will cause cross infection, do not repeated use. Our company assumes no responsibility for any direct, incidental, or consequential damages caused by repeated use of this product.
- 6.4. The balloon should first be filled and dilated outside the body to ensure that there is no leakage or deformation or damage and that the shape of the filled balloon conforms with requirements.
- 6.5. If the balloon comes into contact with a sharp spur when it is dilating inside the body, the balloon may be ripped or torn. The balloon should be deflated at once and removed and replaced if anything abnormal occurs during balloon dilation. If the procedure is not feasible based on the clinician's assessment in the light of the above situation, other surgical options are advised.
- 6.6. This product contains low-protein natural rubber latex ingredients and may cause the following allergic reactions: Itching (pruritus), erythema, rubella, edema, fever, dyspnea, asthma-like symptoms, hypotension, and shock. Stop using the product at once and provide appropriate treatment if one or more of the above symptoms are observed.
- 6.7. Surgery performed using this product should be carried out under general anesthesia with intubation.
- 6.8. Although this type of surgery is relatively safe, it is still accompanied by many complications. A sudden rise or drop in blood pressure, bradycardia, and tachycardia are common complications of the surgery, and sudden cardiac arrest may occur in severe cases. Facial numbness (sensory disturbance) of varying degrees, masseter muscle

weakness, vision affected and herpes are relatively common postoperative complications.

6.9. Improper placement or excessive insertion depth of the balloon catheter can lead to intracranial hemorrhage. It is recommended to perform the procedure with the assistance of medical imaging equipment such as C-arm or O-arm to reduce the likelihood of this potential risk.



6.10. A pressure exceeding the measuring range of the pressure gauge is prohibited. The measuring range of the pressure gauge is -10–600 kPa.

6.11. The user and/or patient that any serious incident that has occurred in relation to the device should be reported to the manufacturer and the competent authority of the Member State.

7. Instructions for Use

7.1. Pressure gauge preparation

Pull out the battery insulation strip to turn on the pressure gauge. Then, the battery status, current pressure value, and pressure unit will be displayed on the pressure gauge (Fig. 6). Long press the button below the screen to toggle through and select the appropriate unit of measurement (atm/kPa/mmHg).

Note: 1. Pay attention to the battery status; Do not use if the battery is running low! 2. Connector 1 needs to be exposed to the ambient air when pulling out the battery insulation strip! 3. The battery symbol  indicates fully charged; The battery symbol is  indicates low voltage. 4. The button needs to be pressed for longer than 0.5 seconds to prevent accidental or unintended touch-activation of the button.

7.2. Balloon pre-filling and deflation

Rotate the cap counterclockwise to take out the inner core from the balloon catheter, fill the syringe with contrast medium (if the contrast medium is too thick or viscous, and dilute the medium to 30% before use to prevent abnormal filling of the balloon); The volume of contrast medium should not exceed 60% of the balloon's maximum liquid filling volume as shown in Table 1.

Fill the syringe with an appropriate volume of the contrast medium using a 2.5 mL syringe and connect the syringe with connector 2 of the pressure gauge; Connect the connector 1 of the pressure gauge to the Luer taper of the balloon catheter; Turn the knob of the pressure gauge to "ON" and inject the contrast medium into the balloon catheter for pre-filling; Place the balloon at a low position and the syringe at a high position and withdraw the contrast medium to discharge air from the balloon; Repeat the above two steps 2-3 times until the air is completely discharged; After the air is completely discharged, ensure that the knob of the pressure gauge is

in the "OFF" state. Fill the syringe with a sufficient volume of contrast medium and connect the syringe to the pressure gauge.

Note: 1. If air has not been discharged from the inner cavity of the balloon, imaging may not be complete when dilating the balloon. In addition, air blasting may occur if the balloon ruptures. In order to prevent the above situations, air should be discharged from the balloon completely. Check the balloon while discharging air and immediately replace the balloon in case of any abnormality such as leakage, severe eccentricity or inability to deflate.

2. After the air has been completely discharged, withdraw the syringe plunger as much as possible to restore the balloon to its original size so that it can easily pass through the sheath of the puncture needle.

7.3. Puncturing

Hold the puncture needle with three fingers between scale mark I and scale mark II, press the rear end of the puncture needle against the palm, and insert the needle at about 2.5 cm from the corner of the mouth (affected side) in the direction of the oval foramen. Check the tip position of the inner needle and the direction of puncture under imaging equipment (CT, C-arm, O-arm or DSA); After confirming that the tip of the inner needle has reached the oval foramen, lightly press down the side wings of the outer sheath hub with one hand, and pull out the inner needle by pinching its hub with the other hand, with the outer sheath remaining in place.

This product is accompanied by 2 puncture needles, .i.e., N-04/N-05. Please select one for use according to the patient's actual conditions.

7.4. Inserting the balloon

Insert the prepared balloon into the Meckel's cave through the outer sheath. Refer to the scale marks on the body of the catheter during insertion; When scale mark I is parallel to the rear end of the outer sheath, it indicates that the head (or the leading end) of the balloon has reached the distal end of the outer sheath. When scale mark II is parallel to the rear end of the outer sheath, it indicates that the balloon has already extended entirely out of the outer sheath, and at this point, the visualization marker rings at the two ends of the balloon can be observed under imaging equipment. Continuously observe the position of the balloon in the Meckel's cave under imaging equipment and adjust it to an appropriate position.

Note: When scale mark III is parallel to the rear end of the outer sheath, it indicates that the balloon has extended 1 cm beyond the outer sheath tube, and at this point, the user should prudently operate the device and should not insert the balloon any further.

7.5. Filling the balloon

Fill the syringe with an appropriate volume of contrast medium (the dose of contrast medium should not exceed the maximum liquid filling volume of the balloon) and connect the syringe to the pressure gauge; Turn the knob of the pressure gauge to the ON position and slowly inject the contrast medium; Pay close attention to the shape of the balloon during filling using imaging equipment. If the position of the balloon is correct, the image shows a pear-like shape (Fig. 7). If the balloon shape is not as expected, the user needs to withdraw the contrast medium and readjust the depth and direction of the balloon until the expected balloon shape is obtained.



Correct Result

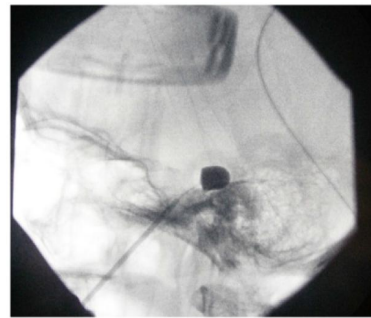

Incorrect and Needing Adjustment

Fig. 7 Images of the balloon after filling

7.6. Balloon compression

After the expected balloon shape is obtained, turn the knob of the pressure gauge to the OFF position, and lock the balloon catheter. Determine the compression time according to the conditions of the patient; A compression time of 90-120 seconds is recommended.

7.7. Pulling out the balloon

After compression is completed, turn the knob of the pressure gauge to the ON position, and draw out the contrast medium from the balloon with the syringe. Once the balloon is completely deflated as indicated by the imaging equipment, pull it out along with the outer sheath. Compress the wound with a bandage.

Note: The balloon may become deformed, crooked or bent after deflation. Do not tug the catheter while withdrawing. It is recommended to retract the outer sheath of the puncture needle by 1-2 cm, then pull out the catheter and the puncture needle altogether.

8. Pressure Gauge Error Prompt

8.1. The battery symbol  will appear and flash when the battery voltage is lower than 2.6 V. Please replace the pressure gauge.

8.2. When the pressure is not within the measuring range of the pressure gauge, that is a pressure lower than -10 kPa or higher than 600 kPa, "---" will appear. In this case, please adjust the pressure.

8.3. “ERR1” will be displayed on the screen when the pressure gauge is unable to detect a value.

Please replace the pressure gauge.

9. Maintenance, Storage and Transportation Requirements

9.1. This product is intended for single use. If abnormality is observed before use, the user can directly contact the distributor or manufacturer.

9.2. This product should be stored away from light in a dry and clean room/warehouse.

10. Expected clinical benefit

Matreneu® PBCCK has a high rate of pain relief, a low recurrence rate, and a low incidence of complications.

11. Product Service Life and Disposal Requirements

11.1. This product is a disposable device sterilized with Ethylene Oxide, with a shelf life of three years. The date of manufacture and lifetime are indicated on the product label, and expired products should not be used.

11.2. The used product must be destroyed in accordance with relevant provisions of the local authority and health department. Do not re-use the product.

12. Packaging & Accessories

The packaging of this product is comprised of an outer carton, a middle packaging box, and an inner plastic container. The packaging is labeled with the product name/specification, service life, batch number, sterilization symbol, qualification certificate, and instructions.

13. Links to the Summary of Safety and Clinical Performance

The SSCP will be available via Eudamed and can be located by using the Basic UDI of Matreneu® Percutaneous Balloon Compression Kit. The Basic UDI for Matreneu® Percutaneous Balloon Compression Kit is 69396986SYM0002EN2J.

14. IFU website link

<http://www.symmedtech.com/Products/1561.html>.

15. Electromagnetic Compatibility

15.1. The pressure gauge complies with the electromagnetic compatibility requirements specified in IEC 60601-1-2 standard.

15.2. The user should install and use the product according to the electromagnetic compatibility information provided in the accompanying documents.

15.3. It is advisable to keep the product far away from portable and mobile radiofrequency communication devices or keep these devices off as they may affect the performance of the pressure gauge. See the attached tables for guidelines and the manufacturer's statement.

15.4. Caution: Using any accessories other than those supplied by this manufacturer may result in increased radiofrequency emission or decreased resistance to interference of the pressure gauge.

15.5. Attached Table 1

15.6. The pressure gauge should not be used near or in an overlapping manner with other devices. If these conditions are unavoidable, observe and verify that the pressure gauge can operate normally under the intended configurations.

15.7. Attached Table 2

15.8. Intrinsic error: The maximum allowable error of the pressure gauge is $\pm 3\%$ for -10–540 kPa, and $\pm 4\%$ for 540–600 kPa.

15.9. Attached Tables 3 and 4

Attached Table 1

Guidelines and the Manufacturer's Statement - Electromagnetic Emission		
The pressure gauge is intended to be used in the following electromagnetic environments, and the buyer or user should ensure that it is used in such electromagnetic environments:		
Emission Test	Conformity	Electromagnetic Environment - Guidelines
Radiofrequency Emission EN 55011	Group 1	The pressure gauge only uses radiofrequency energy for its built-in functions. Therefore, the pressure gauge has a very low radiofrequency emission and is unlikely to interfere with nearby electronic devices.
Radiofrequency Emission EN 55011	Class A	The pressure gauge is applicable to non-home appliances/devices and those not directly connected to residential low-voltage power supply distribution network facilities
Harmonic Emission IEC 61000-3-2	N/A	
Voltage Fluctuation/Blinking Emission IEC 61000-3-3	N/A	

Attached Table 2

Guidelines and the Manufacturer's Statement - Electromagnetic Interference Resistance			
The pressure gauge is intended to be used in the following electromagnetic environments, and the buyer or user should ensure that it is used in such electromagnetic environments:			
Interference Resistance Test	IEC 60601 Test Level	Compliance Level	Electromagnetic Environment - Guidelines
Electrostatic Discharge IEC 61000-4-2	± 6 kV Contact Discharge ± 8 kV Air Discharge	± 6 kV Contact Discharge ± 8 kV Air Discharge	The floor should be wooden, concrete, or ceramic; If the floor is covered with synthetic materials, the relative humidity should be at least 30%.
Electrical Fast Transient/Burst IEC 61000-4-4	N/A	N/A	The network power supply should have the quality necessary for use in a typical business or hospital environment.
Surge IEC 61000-4-5	N/A	N/A	The network power supply should have the quality necessary for use

			in a typical business or hospital environment.
Voltage sags, short interruptions, and voltage changes of the power supply input wire IEC 61000-4-11	N/A	N/A	The network power supply should have the quality for use/service in a typical business or hospital environment. The pressure gauge can be powered by batteries for continuous operation in case of a power interruption.
Power frequency magnetic field (50/60 Hz) IEC 61000-4-8	3A/m	3A/m	The power frequency magnetic field should have the quality necessary for use in a typical location of a typical business or hospital environment.
Note: U_T represents the voltage in an AC network before test voltage is applied.			

Attached Table 3

Guidelines and the Manufacturer's Statement - Electromagnetic Interference Resistance			
The pressure gauge is intended to be used in the following electromagnetic environments, and the buyer or user should ensure that it is used in such electromagnetic environments:			
Interference Resistance Test	IEC 60601 Test Level	Compliance Level	Electromagnetic Environment - Guidelines
Radiofrequency transmission IEC 61000-4-6	3 V (effective value) 150 kHz–80 MHz	N/A	Portable and mobile radiofrequency communication devices should not be used closer to any part of the pressure gauge than the recommended isolation distance, including the cable. This distance is calculated based on the corresponding frequency of the transmitter. Recommended isolation distance $d = 1.2\sqrt{P}$ $d = 1.2\sqrt{P}$ 80 MHz–800 MHz $d = 2.3\sqrt{P}$ 800 MHz–2.5 GHz In the formula: P — Maximum rated output power of the transmitter provided by the transmitter manufacturer, expressed in watts (W); d — Recommended isolation distance, expressed in meters (m) ^b . The field strength of the fixed radiofrequency transmitter is determined by electromagnetic site survey ^a and should be lower than the compliance level for each frequency range ^b . Interference may occur in the vicinity of devices marked by 
Radiofrequency radiation IEC 61000-4-3	3V/m 80 MHz–2.5 GHz	3V/m	
Note 1: For 80-800 MHz, a formula for a higher frequency band should be used.			
Note 2: These guidelines may not be applicable to all situations. Electromagnetic transmission is affected by the absorption and reflection of buildings, objects, and human bodies.			
^a The field strength of fixed transmitters, such as radio (cellular/cordless) telephones, ground mobile radio base stations, amateur radio, FM/AM radio broadcasts, and television broadcasts, cannot be accurately estimated theoretically. In order to evaluate the electromagnetic environment of fixed radiofrequency transmitters, an electromagnetic site survey may be considered. If the measured field strength of the site where the pressure gauge is located is higher than the above applicable radiofrequency compliance level, the user or operator should observe			

the pressure gauge to verify that it can operate normally. If any abnormal performance is observed, complementary measures may be necessary, such as readjusting the direction or location of the pressure gauge.
^b The field strength for the entire frequency range of 150 kHz–80 MHz should be lower than 3 V/m.

Attached Table 4











Recommended isolation distance between portable/mobile radiofrequency communication equipment and pressure gauge			
The pressure gauge is intended to be used in an electromagnetic environment in which radiofrequency radiation disturbance is under control. According to the maximum rated output power of the communication equipment, the buyer or user can prevent electromagnetic interference by keeping the following recommended minimum distance between the portable/mobile radiofrequency communication equipment (the transmitter) and the pressure gauge.			
Maximum rated power output (W) of the transmitter	Isolation distances (m) corresponding to different frequencies of the transmitter		
	150 kHz–80 MHz $d=1.2\sqrt{P}$	80 MHz–800 MHz $d=1.2\sqrt{P}$	800 MHz–2.5 GHz $d=1.2\sqrt{P}$
0.01	0.12	0.12	0.23
0.1	0.38	0.38	0.73
1	1.2	1.2	2.3
10	3.8	3.8	7.3
100	12	12	23











For maximum rated transmitter output power not listed in the above table, the isolation distance d is recommended, expressed in meters (m), and can be determined by the formula in the corresponding transmitter frequency column, where P is the maximum rated output power of the transmitter provided by the manufacturer, expressed in watts (W).

Note 1: For 80–800 MHz, a formula for a higher frequency band should be used.

Note 2: These guidelines may not be applicable to all situations. Electromagnetic transmission is affected by the absorption and reflection of buildings, objects and human bodies.

16. Explanation of Graphics, Symbols, and Abbreviations Used in the Label

Symbol	Explanation
	Fragile, Handle with Care
	Keep away from sunlight
	Keep Dry
	Sterilized using ethylene oxide
	Serial number
	Do not reuse
	Caution
	Country of manufacture
	Use-by date
	Model number

	Batch code
	Manufacturer
	Consult instructions for use or consult electronic instructions for use
	Do not resterilize
	Do not use if package is damaged and consult instructions for use
	Contains or presence of natural rubber latex
	Type B applied parts
	Single sterile barrier system
	Single sterile barrier system with protective packaging outside
	Medical device
	Unique device identifier

17. Medical Disclaimer

- 17.1. The balloon may rupture in some special cases (small Meckel's cave or bone spurs) or improper operation (the puncture is not in place). If this happens, please replace the balloon or use other surgical methods. The rupture of the balloon under these conditions is not a quality problem of the balloon and will not cause any damage.
- 17.2. Shineyard Medical is not responsible for any damage caused due to improper handling, operation and storage, including use after the expiry date given on the product label.
- 17.3. Shineyard Medical is not responsible for any damage to the Matreneu® Percutaneous Balloon Compression Kit or its accessories caused by transportation, handling and storage at the health care facility, whether physical damage or human injury.
- 17.4. Do not use the Matreneu® Percutaneous Balloon Compression Kit or its accessories with other manufacturers' products. Shineyard Medical is not responsible for any damage, whether physical damage or human injury, which may arise from the use of the Matreneu® Percutaneous Balloon Compression Kit or its accessories with other manufacturers' products.



Manufacturer:

Shenzhen Shineyard Medical Device Company Limited.

3/F, Changfeng Industrial Block, No.3 Liuxian Road, Xin'an, Bao'an District, Shenzhen, Guangdong,
518000, China.

P.C. : 518000

Tel: 86 755 26912231, 26918909

Fax: 86 755 26913919

Website: www.symmedtech.com



EU Authorized Representative:

SUNGO Europe B.V.

Fascinatio Boulevard 522, Unit 1.7, 2909VA Capelle aan den IJssel, The Netherlands

Tel: +31(0) 2021 11106

E-mail: ec.rep@sungogroup.com